

# Savi<sup>®</sup> W410/W420

Wireless headset system

User Guide

## Welcome

Congratulations on purchasing your new Plantronics product. This user guide contains instructions for setting up and using your Savi W410/W420 (D100 USB Adapter + WH300/350 Headset) Wireless Headset System.

Please refer to the separate [safety instructions](#) for important product safety information prior to installation or use of the product.

# Contents

1 Package Contents.....	4	6 Making Calls With Your Headset and PC .....	11
2 System Features.....	5	Software installation .....	11
3 Headset Setup.....	6	Making calls with your headset and PC .....	11
Installing the headset battery.....	6	Softphone support.....	1
Customize your headset.....	6	Auto answer.....	11
Assembling Base .....	6	Conferencing up to three guest headsets .....	12
4 System Setup.....	7	7 Plantronics Control Panel .....	13
Connecting the power supply.....	7	Devices tab .....	13
Docking and charging the headset.....	7	Applications tab.....	15
Connecting the USB adapter to your PC .....	7	Preferences tab.....	16
Loading software .....	7	About tab .....	16
USB adapter indicator light .....	8	8 Plantronics Update Manager.....	17
5 Using Your Headset System.....	10	9 Troubleshooting and Common Questions .....	18
Powering up the headset.....	9		
Talk time.....	9		
Muting a headset during a call .....	9		
Placing, Answering, Ending Calls with Desk Phone .....	9		
Placing the headset in sleep mode.....	10		
Headset tones.....	10		
Battery life.....	10		
Headset indicator light.....	10		
Subscribing a headset.....	10		
Ending subscription .....	10		

# 1 Package Contents

---

## Savi W410/W420 USB Adapter and Charger

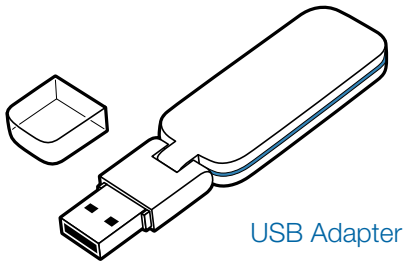

USB Adapter

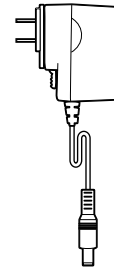

Base Power Supply

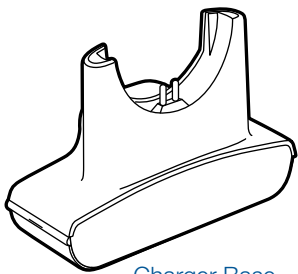

Charger Base

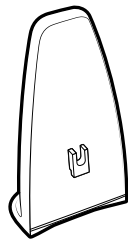

Base Stabilizer

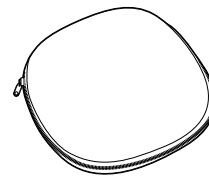

Carrying Case

---

## Savi WH300/350 Headset



Headset

# 2 System Features

---

## Savi USB Adapter Features

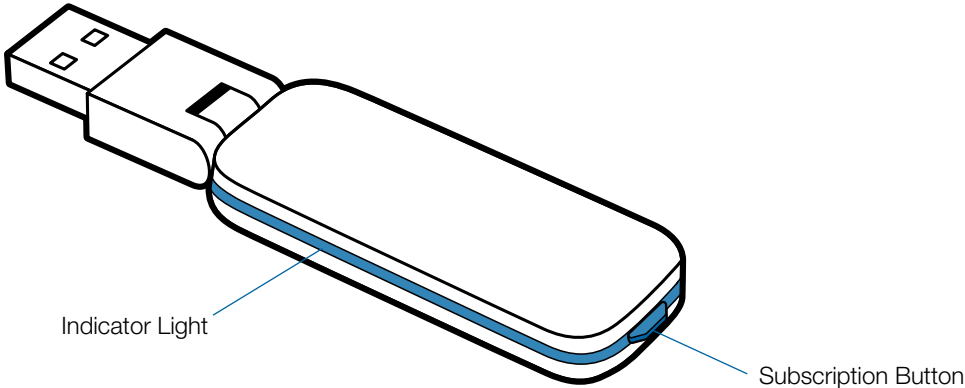

---

## Savi WH300/350 Headset Features

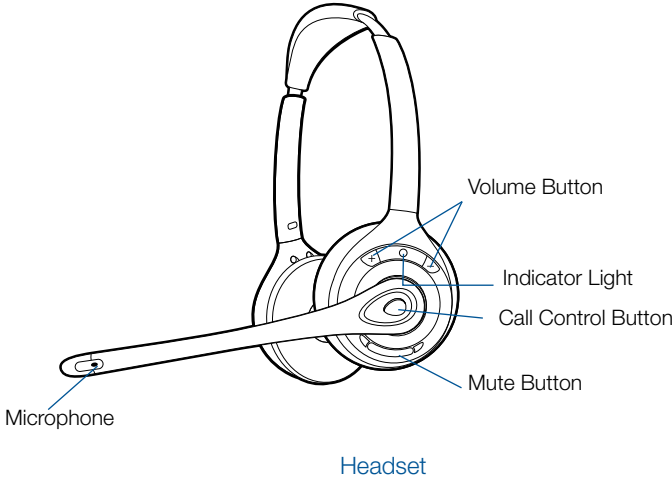

# 3 Headset Setup

## 3.1 Adjust the Headband

- 1 To adjust the headband, lengthen or shorten the band until it fits comfortably. Position the headset receivers so that the foam cushions sit comfortably over the center of your ears.**
- 2 On the WH300, position the stabilizer T-bar above your ear.**
- 3 For a tighter fit, gently pull the opposite ends of the headset inward as shown.**

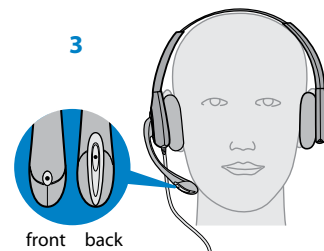
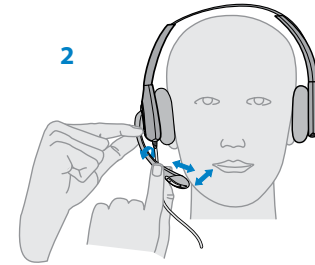
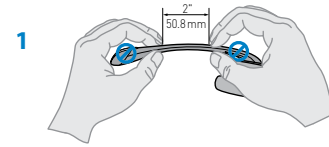
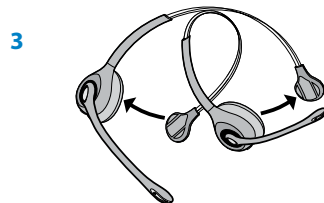
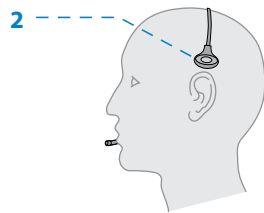

## Assembling Base

- 1 Separate the top from the bottom of the charger base.**
- 2 Attach the base stabilizer to the base, then re-attach the top.**

**NOTE** This product has a replaceable battery. Use only the battery type supplied by Plantronics.

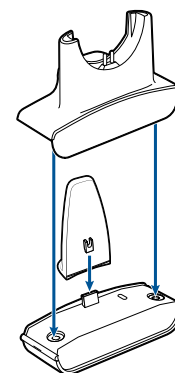

## 3.2 Adjust the Mouthpiece

- 1 Carefully bend and shape the boom with both hands as shown. Avoid bending or twisting the boom near the microphone or earpiece.**
- 2 Position the click-stop turret and boom so that the microphone is two finger-widths from the corner of your mouth.**
- 3 Make sure the front of the microphone faces your mouth.** If necessary, twist the microphone slightly so it's in the proper position. Do not use forceful twisting motions or try to turn the microphone completely around.

# 4 System Setup

## Connecting the Power Supply

- 1 **Connect the base power supply into the power jack on the charger base.**
- 2 **Connect the power supply to the outlet.** The power indicator light will be solid green..

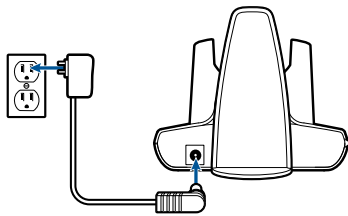

## Docking and Charging the Headset

- 1 **Gently push the headset into the charging cradle.**  
The charging indicator light on the headset will flash green to indicate that the headset battery is charging.
- 2 **Charge for at least 20 minutes prior to first use.** A full charge takes 3 hours.

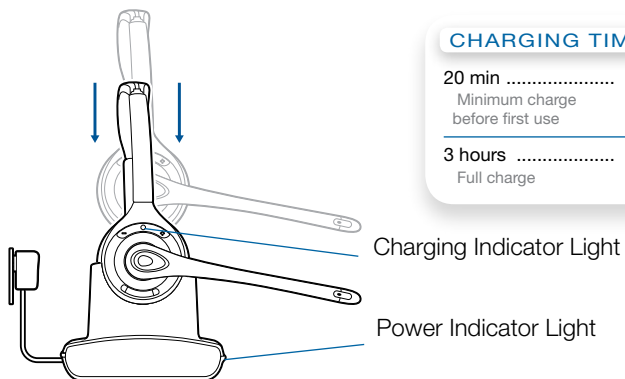

## Connecting the USB Adapter to your PC

- 1 **Insert the USB adapter into USB Port on PC.** The indicator light on the USB adapter will be solid red to indicate the USB adapter is powered on and will turn solid green when it finds the headset.

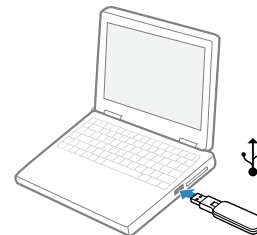

**NOTE** The headset may have to be charged before the USB adapter can find it.

- 2 **The USB adapter can be folded as shown.**

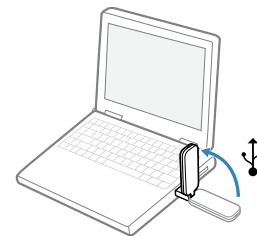

**IMPORTANT NOTE** For best performance it is recommended that Windows is updated with Service Pack levels listed below:

Microsoft Windows® XP Service Pack 3 (SP3) or later  
Microsoft Windows Vista® Service Pack 1 (SP1) or later

## Loading software

- 1 **Load the software by visiting [plantronics.com/software](http://plantronics.com/software) and click on the download button.**

## USB Adapter Indicator Light

USB Adapter Status	USB Indicator Light
Headset subscribed, no activity	Solid green
Headset in talk mode	Flashes green
Headset muted	Flashes red
Incoming call	Flashes red and yellow
Headset not subscribed	Solid red
USB adapter subscription	Flashes green and red
USB adapter conference subscription	Flashes green and yellow
On conference call with one or more guest headsets subscribed	Flashes yellow



# 5 Using Your Headset System

## Powering Up the Headset

If the headset battery is charged and connected to the headset, the headset is automatically on. The headset does not have an on/off button.

## Talk Time

With a single full charge, the Savi W410/W420 will provide up to 9 hours of talk time. Talk time will be reduced when operating in wideband mode and/or if the headset is used consistently at a far distance from the adapter.

## Muting a Headset During A Call

Short press the dedicated mute button to toggle mute on/off. The USB adaptor light will flash red when the headset is muted.

When mute is activated, you will hear three high tones. When unmuted, you will hear three low tones.

After the Plantronics software is loaded, the mute tones can be turned off by going to Start > Programs > Plantronics Control Panel > Devices > Device Settings > Headset – Mute Tone.

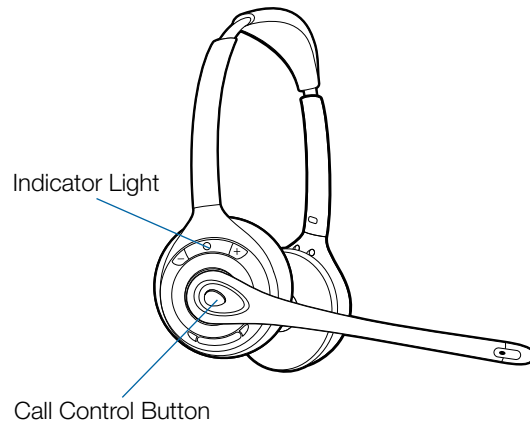

*For your safety, do not use headset at high volumes for extended periods of time. Doing so can cause hearing loss. Always listen at moderate levels. For more information on headsets and hearing visit:*

[plantronics.com/healthandsafety](http://plantronics.com/healthandsafety).

## Placing, Answering, and Ending Calls with Desk Phone

	Phones with Handset Lifter or Electronic Hookswitch	Phones without Handset Lifter or Electronic Hookswitch
To place a call	<ol style="list-style-type: none"><li>1. Short press call control button on headset* or short press base desk phone talk button</li><li>2. Dial number</li></ol>	<ol style="list-style-type: none"><li>1. Short press call control button on headset* or short press base desk phone talk button</li><li>2. Remove handset from cradle**</li><li>3. Dial number</li></ol>
To answer a call	<ol style="list-style-type: none"><li>1. Short press call control button on headset or short press base desk phone talk button</li></ol>	<ol style="list-style-type: none"><li>1. Short press call control button on headset or short press base desk phone talk button</li><li>2. Remove handset from cradle**</li></ol>
To end a call	<ol style="list-style-type: none"><li>1. Short press call control button on headset or short press base desk phone talk button</li></ol>	<ol style="list-style-type: none"><li>1. Short press call control button on headset or short press base desk phone talk button</li><li>2. Return handset to cradle**</li></ol>

\*Assumes use of supported softphone

\*\*Assumes your default line is set to PC

## Placing the Headset in Sleep Mode

If you won't be using the headset for a long period of time and the headset will not be in the charging cradle, you can put the headset in sleep mode. With the headset idle, press the call control button for three seconds until you see the headset flash green twice. To wake the headset, press the call control button again and you will see two green flashes.

## Headset Tones

### Out of range warning

If you are on a call and go out of the operating range, you will hear three low tones. You will hear a single mid tone when you are back in range.

If you stay out of range, active calls will be suspended. Calls will be re-established when you walk back into range. If you remain out of range for more than 5 minutes, the system will drop the call.

If you are not on a call and go out of the operating range and press the call control button, you will hear a single tone for the button press and three low tones for the failure to make a link.

### Low battery warning

If you are on a call, you will hear a repeated single low tone every 15 seconds indicating that the battery is low. You should recharge the headset immediately.

If you are not on a call and press the call control button, you will hear three low tones indicating that the battery is low. You should recharge the headset immediately.

## Battery Life\*

At the lower right corner of your screen in your system tray, your headset battery status will be indicated with one of the following icons:



A warning will be issued if your headset is critically low.

\* Requires Plantronics software installation, see Software Installation.

## Headset Indicator Light

If you are not on a call, you can toggle the headset in-use indicator light on and off by pressing the headset volume down button for three seconds.

## Subscribing a Headset

The headset and USB adapter that are supplied together are already subscribed to each other. However, if you wish to use a new headset with your existing USB adapter or you need to restore subscription to your current headset, the units can be subscribed to each other by the following method:

- 1 Ensure your headset is charged.**
- 2 Double press the subscription button on the USB adapter.** The USB adapter will flash red and green.
- 3 Press the volume up button on the headset for three seconds until the headset indicator light turns solid green.**
- 4 When the indicator light on the USB adapter goes solid green, the headset and the USB adapter are subscribed to one another.**

To ensure subscription was successful, press the call control button: the headset will flash green and the USB adapter will flash green.

**NOTE** If the subscription process times out after two minutes or if the subscription process fails, the USB adapter indicator light will become solid red for four seconds and then return to its previous state. If this occurs, try to re-subscribe the headset again.

## Ending Subscription

If the USB adapter is in subscription mode and you want to stop the adapter from searching for a headset, press the subscription button again. The subscription light will turn solid red for four seconds and then go to its previous state.

# 6 Making Calls With your Headset and PC

## Software Installation

It is highly recommended that you install the Plantronics software. Though your Savi system will operate without the software, it will limit the system's full capabilities.

Install the Plantronics software to enable remote call answer/end with compatible softphones. The software can be downloaded at [plantronics.com/software](http://plantronics.com/software).

After installation, to visit the Plantronics control panel, click on Start > Programs > Plantronics > Plantronics Cool Panel.

Plantronics Spokes for Windows software runs on the Intel® x86 and x64 platform (including compatible CPUs from other manufacturers) running Windows 8, 7, Vista SP2 and XP SP3 (x86 only) (Basic, Professional and Enterprise Editions).

## Making Calls With Your Headset and PC

	With Plantronics Software and a Compatible Softphone	Without Plantronics Software
To place a call	Dial number from a compatible softphone application	1. Short press call control button on headset 2. Dial number from softphone application
To answer a call	Short press call control button on headset	1. Short press call control button on headset 2. Answer call using softphone application
To end a call	Short press call control button on headset	1. Short press call control button on headset 2. Hang up call using softphone application

## Softphone Compatibility

Remote call answer/end from the Savi headset is available for all softphones with no additional steps by the user except Skype™. For a list of compatible softphones visit [plantronics.com/software](http://plantronics.com/software).

For Skype support, please follow these steps:

- 1 Skype will display the following message during the install of Plantronics Unified Runtime Engine "PlantronicsURE.exe wants to use Skype". Choose "Allow Access" to connect.
- 2 You can also check Savi W410/W420 Skype connection status by going to Skype and checking the Tools > Options > Advanced > Advanced Settings > "Manage Other Programs Access" setting.

## Auto Answer

Auto answer saves the user a button press to establish the radio link between headset and adapter.

The Savi W410/W420 is supplied with auto answer NOT SELECTED as the default. When auto answer is set to NOT SELECTED you must press the headset call control button to answer an incoming call. When Auto Answer is set to SELECTED an incoming call will be answered when the headset is removed from the charge cradle.

To change the setting, go to: Start > Programs > Plantronics > Plantronics Control Panel > Device Settings – USB adapter.

## Conferencing Up to Three Guest Headsets

While on a call, you can subscribe up to three guest headsets to your USB adapter for conferencing. As you add headsets to the adapter, an additional headset icon will appear in the Plantronics Control Panel with a number from 1 to 3 indicating the number of guest headsets subscribed to the adapter.

Guests may conference in as described below:

- 1** While you are on a call, place the guest's headset into subscription mode.
- 2** Short press (less than one second) the subscription button on the USB adapter. The USB adapter light will flash yellow and green.
- 3** The USB adapter light will then turn solid yellow and you will hear a tone in the master headset indicating a guest wishes to join the call.
- 4** If you press the call control button on the master headset within five seconds, the guest is joined to the call.

If you do not press the call control button within five seconds, the request to join the call is rejected and the guest will hear an error tone in their headset.

- 5** Guests may leave the conference call by pressing their call control button.

When they do you will hear a single tone in the master headset as each guest leaves the call.

To see how many headsets are subscribed to the adapter, refer to the lower left-hand corner of the Plantronics Control Panel. The first headset is the master headset and the number inside the next headset is the number of guest headsets subscribed to the adapter. The examples below show 1, then 2, then 3 guest headsets subscribed to the adapter in addition to the master headset.



# Plantronics Control Panel

User preferences and various device settings can be changed using the Plantronics Control Panel. To start this program, click Start > Programs > Plantronics > Plantronics Control Panel.

## Devices Tab

To configure your settings, select Plantronics D100 from the pull down menu and click the Device Settings box. Below are the setting options and defaults for the USB adapter and headset.

**NOTE** Some parameters that do not apply to a particular Plantronics device may appear grayed out.

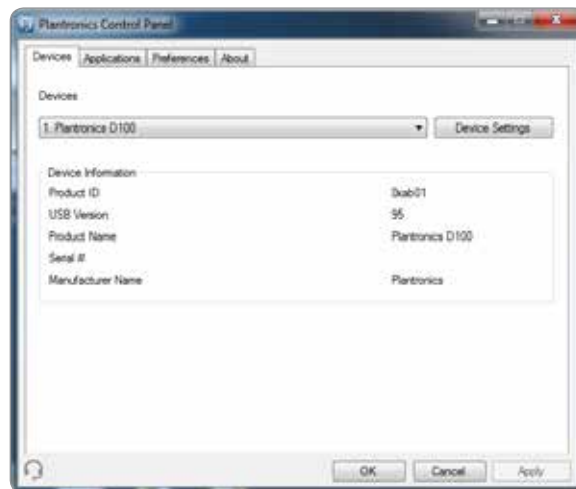

## Device Settings – USB Adapter Tab

Options	Feature	Settings	Default
General	Range	High/Med/Low	High
	Auto Answer	Selected/Not selected	Not selected
Audio	PC Audio Bandwidth	Wideband/Narrowband	Narrowband
Feature Set Lock	Password (required)	Locked/Unlocked	Unlocked

### Range

The Savi W410/W420 is supplied with high range set as the default. Range can be minimized to help with PC buzzing, improve user density, or restrict range of users.

To change the Range default in the software, go to : Start > Programs > Plantronics > Plantronics Control Panel > Device Settings – USB adapter. You can also change the range setting by holding in the subscription button of the USB adapter for three seconds while it is in an idle state. The USB adapter light will flash green for high range, yellow for medium range and red for low range.

When Range is set to HIGH a user will have up to 300 feet of range. When Range is set to MEDIUM a user will have up to 150 feet of range. When Range is set to LOW a user will have up to 50 feet of range.

### Auto Answer

The Savi W410/W420 is supplied with auto answer NOT SELECTED as the default. Auto answer saves the user a button press to establish the radio link between headset and adapter.

When auto answer is set to NOT SELECTED you must press the headset call control button to answer an incoming call. When Auto Answer is set to SELECTED an incoming call will be answered when the headset is removed from the charge cradle.

To change the default, go to: Start > Programs > Plantronics > Plantronics Control Panel > Device Settings – USB adapter.

### PC Audio Bandwidth

The Savi W410/W420 is supplied with narrowband audio as the default. Wideband audio delivers heightened speech clarity and life-like fidelity. However, wideband audio consumes more battery power and has more stringent access criteria which reduces the number of systems that can be deployed in a small area. All PCs support wideband audio.

To change the PC Audio Bandwidth default in the software, go to: Start > Programs > Plantronics > Plantronics Control Panel > Device Settings – USB adapter. You also can toggle between narrowband and wideband audio by doing a short press (less than one second) followed by a long press (more than three seconds) on the USB adapter subscription button while it is in an idle state. The USB adapter light will flash red for four seconds upon entering narrowband mode and flash green for four seconds upon entering wideband mode. When switching between narrowband and wideband audio, you must re-establish the audio link for the changes to take effect.

### Feature Set Lock

See the Device Settings – Security Tab for more information.

### Device Settings – Headset Tab

Options	Feature	Settings	Default
General	Mute Tone	Standard/Low/Off	Off
	Ringtone	Sound 1/Sound 2/Sound 3	Sound 2
	PC Volume	Standard/Low/Off	Standard
	System Tones	Standard/Low/Off	Standard
	Second Inbound Call	Ring Continuously/Ring Once/Ignore	Ring Continuously

### Device Settings – Advanced Tab

Options	Feature	Settings	Default
Audio Protection	Anti-Startle	Selected/Not selected	Not selected
	G616*	Selected/Not selected	Not selected
	Audio Limiting*	80 dB/85dB/Off	Off
	Hours on Phone Per Day	2/4/6/8	8
Feature Set Lock	Password (required)	Locked/Unlocked	Unlocked

\*The Audio and G616 Limiting features are supported in over-the-head mode only and are based on a typical headset and recommended acoustic coupling between the headset and the ear. Please see Headset setup for optimal wearing position.

### Anti-Startle

Anti-startle provides advanced hearing protection against sudden loud sounds. When Anti-startle is SELECTED, the system identifies and eliminates sudden loud sounds and rapidly reduces them to a comfortable level. When Anti-startle is NOT SELECTED, the headset limits sound levels at 118 dBA to protect your hearing.

### G616

G616 Acoustic Limiting provides additional hearing protection against acoustic shock. When G616 Acoustic Limiting is SELECTED, the system provides additional acoustic shock protection. Sound levels are limited to 102 dBA as recommended in the G616:2006 guideline issued by the Australian Communications Industry Forum (ACIF). When G616 Audio-Limiting is NOT SELECTED, the headset limits sound levels at 118 dBA to protect your hearing.

### Audio Limiting

Audio Limiting provides advanced hearing protection for daily noise exposure. When Audio-Limiting is SELECTED, the system monitors and controls sound to ensure audio levels do not exceed 80 dBA or 85 dBA (whichever is selected) specified by current and imminent EU legislation. When Audio-Limiting is set to NOT SELECTED, the headset limits sound levels at 118 dBA to protect your hearing.

### Feature Set Lock

See the Device Settings – Security Tab for more information.

## Device Settings – Security Tab

Options	Feature	Default
Feature Set Lock	Create new password	None
	Change password	None

### Feature Set Lock

The Plantronics software allows the following device settings to be locked by the IT staff and prevent end users from changing them.

- Range
- Auto Answer
- PC Audio Bandwidth
- Audio Protection (Anti-Startle, G616, Audio Limiting and Hours on phone per day)

The ability to lock/unlock these settings requires a password. In order to lock/unlock any setting follow these steps:

#### 1 Create a new password

**From the Security screen, create and confirm your new password and press Set.** This will store the password directly in the device.

#### 2 Lock/unlock a device setting

From the USB Adaptor or Advanced screen, enter your password in Feature Set Lock, lock/unlock each feature as desired and click Apply.

### Change Your Password

You can always change the old password to a new one in the Change Password section. You will only be able to change a password if there is a previous password set in the device.

**NOTE** In case you forget your password, you will need to call your local Plantronics Technical Support for assistance.

## Applications Tab

The Applications Tab displays the status of Plantronics support for various applications such as softphones and media players. The status will only show as “enabled and running” for softphones and media players installed and running.

## Preferences Tab

The Preferences Tab allows you to set preferences for the media player as well as other general settings.

Options	Feature	Settings	Default
Media Player	Action to Media Player – When a call begins – When a call ends	Mute/pause/do nothing Play/do nothing	Pause Play
General	Launch audio devices control panel	(Provides a shortcut to the Windows Sounds and Audio Devices control panel.)	
	Ring Both Headset and PC	Selected/Not selected	Not selected
	Microsoft OC/Lync Dial-tone Enabled	Selected/Not selected	Not selected
	Audio Sensing Enabled	Selected/Not selected	Not selected
	Maintain Headset to PC Link	Selected/Not selected	Not selected

### Ring Both Headset and PC

This parameter gives you the option to have the PC ringtone played on both the headset as well as the PC speaker.

When this parameter is selected, the PC ringtone will be heard on both the PC speaker as well as the headset.

When this parameter is not selected, the PC ringtone will only be heard on either the headset or the PC speaker based on how the PC audio has been set up.

### Microsoft OC/Lync Dial-tone Enabled

If this feature is selected, when a PC radio link is established, Microsoft OC/Lync will assume the user is trying to place a VoIP call and provide a dial tone.

If this feature is not selected, when a PC radio link is established, Microsoft OC/Lync will sit idle.

### Audio Sensing Enabled

Audio Sensing is a special feature supported by Plantronics wireless devices that can detect an audio signal at the USB port and automatically establish a PC radio link between the USB adapter and wireless headset without the user having to press the PC call control button. If the parameter “Microsoft OC/Lync Dial-tone Enabled” is selected, then every time a PC radio link is established the Microsoft OC/Lync dial tone will be heard. However, the user may have pressed the PC call control button

to listen to music, etc., and does not want to hear the dial-tone. In this case, if the user selects the “Audio Sensing Enabled” parameter, the radio link will be established automatically when any PC audio is detected at the USB port, thus eliminating the need for the user to press the PC call control button.

### Maintain Headset to PC Link

This parameter forces the radio link to the PC to stay active even after the call has ended. This can eliminate the need to re-establish the radio link when switching between PC audio applications.

## About Tab

The About Tab provides on-line access to this printable user guide and also includes Plantronics contact information. The current version of software and firmware currently running on your system is also shown here.



# 8 Plantronics Update Manager

All required software for Savi W410/W420 can be remotely updated when updates are available. Start Plantronics Update Manager from Windows Start Programs menu to change settings such as automatic or manual check for updates.

## Check for Updates Automatically

By enabling this check box, you will activate a periodic automatic check for available software updates.

## Check for Updates Now

You can choose to check for available software updates at any time by clicking on the Check For Updates Now button in Update Manager. From the Start menu > Programs > Plantronics > Plantronics Update Manager.

## Install Checked Updates

Following an **Automatic** or **Manual Check For Updates**, this field will be populated with any applicable software updates and the **Install Checked Updates** will begin installation.

# 9 Troubleshooting and Common Questions

---

When I dial from my softphone application, nothing happens.

Ensure your headset is charged.

Ensure your headset is subscribed to the USB adapter. See [Subscribing a Headset](#).

Ensure that the Plantronics software is installed. To download, visit [plantronics.com/software](http://plantronics.com/software).

Ensure that you are using a compatible softphone application. For a list of compatible softphones, visit [plantronics.com/software](http://plantronics.com/software).

If the Plantronics software is not installed and you do not have a compatible softphone, you must first press the call control button and then use the softphone interface to place/answer/end calls.

Ensure that the headset is the default sound device. The Plantronics control panel will launch the sound devices control panel by going to Plantronics Control Panel > Preferences > General – Launch Audio Devices Control Panel.

Disconnect and re-connect the USB adapter. It will be solid red until it subscribes to the headset; it will be solid green when successfully subscribed to the headset.

Restart your computer.

---

Speaking and/or listening volume is too low or too high.

Adjust headset listening volume with volume button.

Adjust listening/speaking volumes in the computer's sound control panel/system preferences.

Adjust listening/speaking volumes in the softphone application.

---

The sound is distorted or I hear an echo in the headset.

Reduce speaking and/or listening volume on the computer using your softphone application.

Point microphone towards your chin.

If the distortion is still present, lower the volume on the headset.

---

I can no longer hear any audio through my PC Speakers.

For Windows XP systems

- Refer to the "Audio" tab of the "Sounds and Audio Devices" option in your PC Control Panel.
- Under "Sound Playback", change the default setting from Savi Office to your PC speakers. Click "OK" to confirm your change.

For Windows Vista systems

- Refer to the "Sound" option in your PC Control Panel.
- Under the "Playback" tab, change the default setting from "Speakers Savi Office" to your PC speakers. Click "OK" to confirm your change.

For Mac OS X

- Choose Apple menu > System Preferences and click Sound.
- Click Output, and then select "Internal Speakers" or your speaker choice.

---

Talk time performance is significantly degraded even after a full recharge.

The replaceable battery is wearing out. Contact [plantronics.com](http://plantronics.com) to purchase a new battery. Use only the battery type supplied by Plantronics.

---

Plantronics, Inc.  
345 Encinal Street  
Santa Cruz, CA 95060  
United States  
plantronics.com

Plantronics BV  
South Point Building C  
Scorpius 140  
2132 LR Hoofddorp  
Netherlands

For product support contact us at [plantronics.com/support](http://plantronics.com/support) or call 1-800-544-4660.

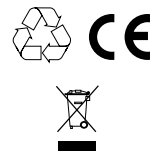

EEE Yönetmeliğine Uygundur

© 2013 Plantronics, Inc. All rights reserved. Plantronics, the logo design, Savi, W410/W420, and Sound Innovation are trademarks or registered trademarks of Plantronics, Inc. Microsoft, Windows and Vista are trademarks or registered trademarks of Microsoft Corporation. Skype is a trademark of Skype Limited or other related Skype companies.

Patents US D538,785; US D505,413; US D535,285; EM 000543798-0004; EM 000543798-0005; CN 200630123314.7; CN 200630123313.2; TW D117515; TW D117333; Other Patents Pending

89922-06 (01.13)

**plantronics**