

# Calisto 7200

## USB Speakerphone

User Guide

# Contents

Overview	3
Connect to PC	4
Daily Use	5
Power	5
Volume	5
Mute/Unmute	5
Answer or End a call	5
Low Battery Behavior	5
Pair with a Bluetooth device	6
Unpair a Bluetooth device	6
Charge	7
Switch between paired devices	8
Clear stored Bluetooth devices	9
Indicator lights explained	10
Security cable	11
Support	12

# Overview

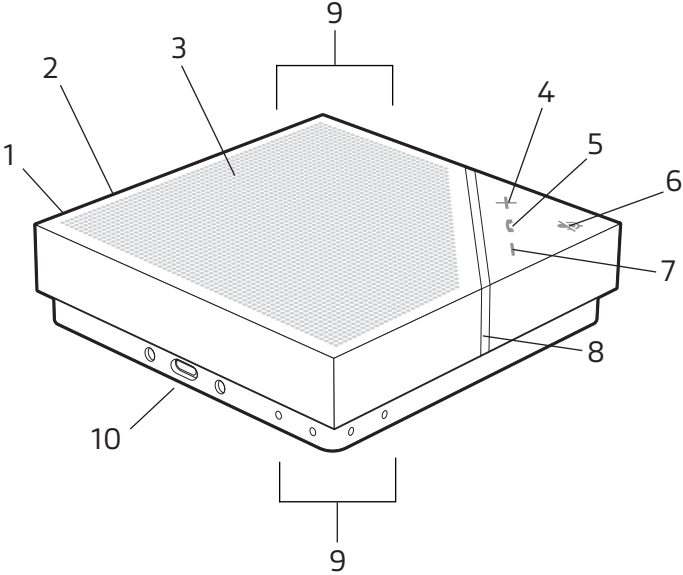

- 1 Power button
- 2 Bluetooth® button
- 3 Speaker
- 4 Volume up
- 5 Handset
- 6 Mute
- 7 Volume down
- 8 Indicator light
- 9 Microphones
- 10 Micro USB port

# Connect to PC

Connect the speakerphone to your computer using a micro USB cable and use the speakerphone to play music or call audio.

- 1 Connect the USB cable from the USB port on the speakerphone to the USB port on your computer.

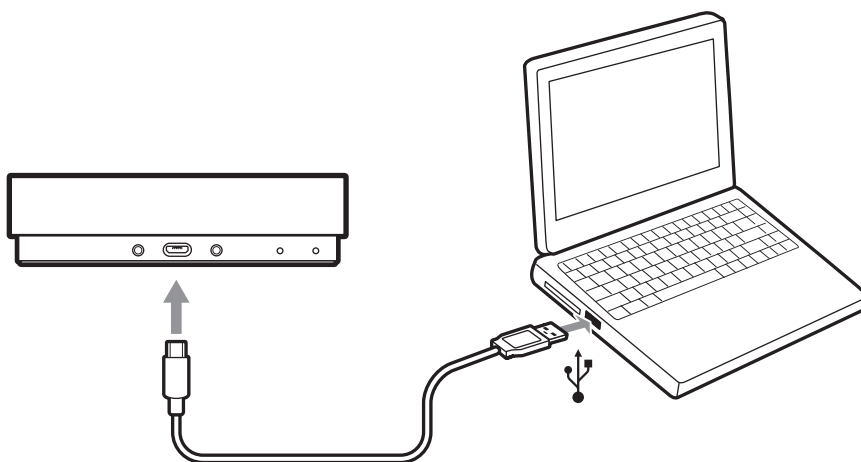

- 2 Set the speakerphone as your default audio device in your computer's system settings.

# Daily Use

## Power

When the device boots up, the Status Indicator will illuminate solid white for 2-3 seconds to complete boot-up. Then power-on tone will play, volume buttons illuminate and Status Indicator will turn off, signifying that the device is ready to use.

Give the power button a short press to power on the device. Press and hold the power button for 2 seconds to power off the device.

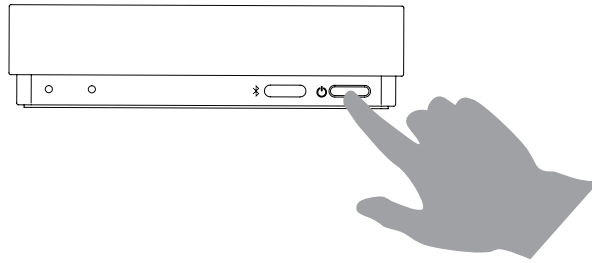

The speakerphone automatically turns off after 10 minutes of inactivity, if not plugged into a power source.

## Volume

Press the up (+) or down (-) volume buttons for the desired volume.

## Mute/Unmute

A short press of the Mute button mutes or unmutes the microphones.

## Answer or End a call

A short press of the Call button answers or ends a call.

## Low Battery Behavior

When the battery drops to 16% the power button will periodically pulse amber. The LED behavior is accompanied by an audible tone, unless the user is in a call.

When the battery drops to 6%, the power button will display with more urgency. The LED will persistently pulse amber, with the tone only sounding intermittently.

**NOTE** *If the battery level is at 5% or lower at a power off state, the speakerphone will not respond to attempts to power it on unless plugged into a power source.*

# Pair with a Bluetooth device

- 1 Press and hold the Bluetooth button for 2 seconds.

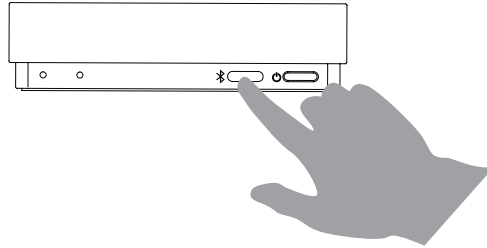

The indicator light flashes blue when in pairing mode.

- 2 On your device, enable Bluetooth and select **PLT P7200** from the list of devices. When the devices are paired successfully, the speakerphone will play a tone and the indicator light will turn solid blue, momentarily. The device will automatically connect with the speakerphone when in range.

## Unpair a Bluetooth device

After you are finished using the speakerphone with a Bluetooth device, unpair the speakerphone from your device. To unpair the speakerphone do one of the following:

- 1 Press the Bluetooth button on your speakerphone.
- 2 Disconnect from the speakerphone on your Bluetooth device.

# Charge

Charging the speakerphone can take 3 to 6 hours, depending on the battery level and charging method. Do one of the following:

- 1 Connect the micro USB cable from the USB port on the speakerphone to the USB port on your computer.

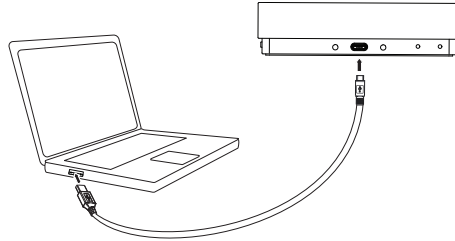

2

Connect the micro USB cable from the speakerphone to a USB plug then plug into an outlet.

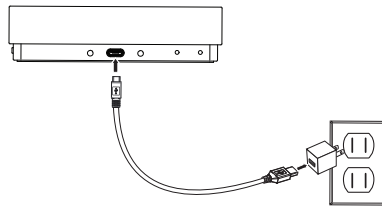

If the speakerphone is powered on while charging, the power button will pulsate until the battery is full, and then will shut off (or revert to appropriate state depending on activity).

# Switch between paired devices

The speakerphone can pair up to 10 devices and connect with up to two devices. However, the speakerphone can only transmit audio for one device at a time. To switch between devices, do one of the following:

- 1 Turn off Bluetooth on one of the connected devices.
- 2 Stop playing audio on one device and start playing audio on another connected device.



# Clear stored Bluetooth devices

The speakerphone can remember up to 10 paired devices. Clear the Bluetooth cache to remove any data from your device stored on the speakerphone.

Press and hold the Bluetooth and volume down (-) buttons for five seconds. An audio tone plays and the indicator light flashes blue.

# Indicator lights explained

Indicator	Status
Amber	Charging battery
Blinking amber	Low battery
Pulsing amber	Software update
Blue	Bluetooth paired
Blinking blue	Pair/discovery mode
Green	In a call
Blinking green	Incoming call
Red	Mics muted
White	Power on

# Security cable

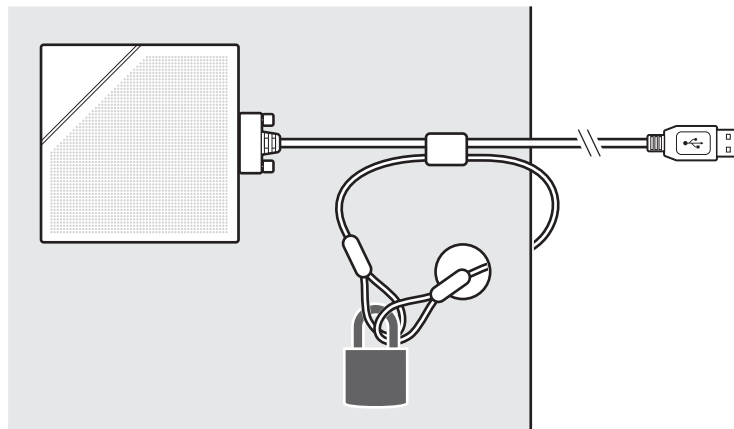
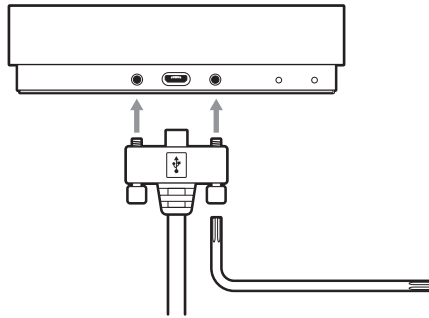

# Support

## NEED MORE HELP?

[plantronics.com/support](https://plantronics.com/support)

**plantronics®**  
Simply Smarter Communications™

**Plantronics, Inc.**

345 Encinal Street  
Santa Cruz, CA 95060  
United States

**Plantronics BV**

Scorpius 171  
2132 LR Hoofddorp  
Netherlands

© 2018 Plantronics, Inc. Bluetooth is a registered trademark of Bluetooth SIG, Inc. and any use by Plantronics, Inc. is under license. All trademarks are the property of their respective owners.

212267-06 (03.18)