

CA22CD-SC/CA22CD-DC Push-to-Talk headset adapter

User Guide

Contents

DECT Information	3
DECT Enhanced Security	3
Overview	4
Remote overview	4
Base overview	5
Spares and Accessories	6
Spares and replacements	6
Accessories	6
Compatibility of remotes and bases	7
Connect your system	8
Analog	8
USB (USB variant only)	8
Remote	9
Adjust the volume controls	10
USB connection	10
Analog connection	10
Subscribe	12
Charge	13
Charge your remote	13
Manage batteries	13
System basics	14
Power remote	14
Key up radio	14
Adjust headset microphone volume (softphone)	14
Stay within range of your base	14
Troubleshooting	15
15	
Support	16

DECT Information

DECT products should never be used outside the region in which they were originally purchased and intended to be used.

The enclosed DECT 6.0 wireless product uses restricted wireless radio frequencies which vary by country. DECT 6.0 devices are generally authorized for use in the US/Canada/Mexico. Use of this DECT 6.0 product in unauthorized countries is a violation of law, may disrupt telecommunications networks and devices, and can subject you to fines and penalties by regulatory agencies.

DECT Enhanced Security

Poly is a member of the DECT Forum and has fully adopted their recommendations for enhancements to security within all DECT products.

Poly DECT-based products now fully incorporate the latest recommendations on Enhanced Security from the DECT Forum and ETSI. These improvements cover registration, authentication, authorization and encryption procedures. Poly DECT products are now secure against known vulnerabilities that were highlighted by the public announcements of the Chaos Communication Congress in 2009.

Poly DECT products meet the requirements for the DECT Forum security certifications.

Poly DECT products use the new enhanced version of DECT that includes these security improvements.

Overview

Remote overview

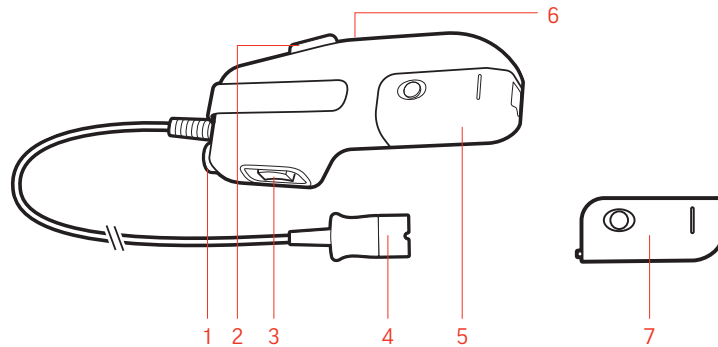

1	Audio Link LED button	Turns the audio link between remote and base on and off.
2	Push-to-Talk (PTT) button	Keys up the communications radio.
3	Rocker switch	1. Adjusts listen sensitivity in 2-dB steps. 2. Places the remote into Subscription Mode when pressed and held in either the Up or Down position.
4	Quick Disconnect (QD)	Connects to headset. NOTE <i>Single Channel QD shown. Connection may vary but function is the same.</i>
5	Battery pack	Powers remote.
6	Momentary/Locking PTT selector	Enables or disables locking operation of the PTT button.
7	Spare battery pack	Swap batteries regularly to maximize battery life.

Be safe

Please read the safety guide for important safety, charging, battery and regulatory information before using your new device.

Base overview

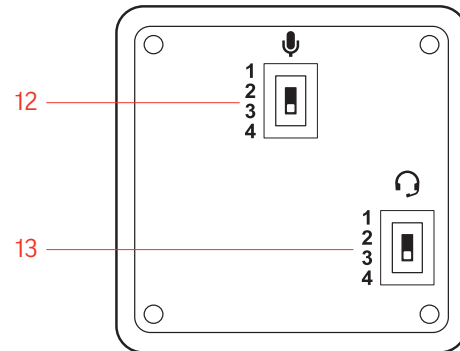
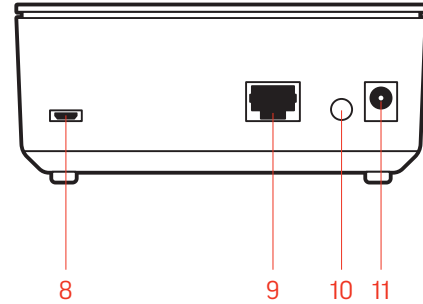
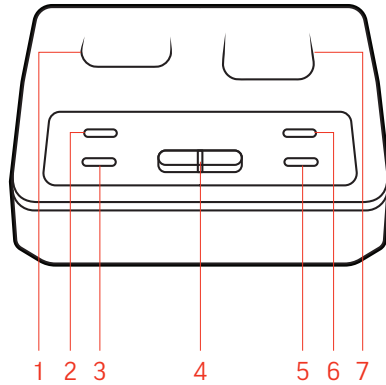

- 1 Spare battery charging well
- 2 Spare battery charge LED
- 3 Base power LED
- 4 Talk volume buttons
- 5 Push-to-Talk (PTT) LED
- 6 Remote charge LED
- 7 Remote charging well

- 8 USB port
- 9 Console interface jack
- 10 Subscription button
- 11 AC power jack
- 12 Talk coarse-adjust switch
- 13 Listen coarse-adjust switch

Spares and Accessories

Spares and replacements

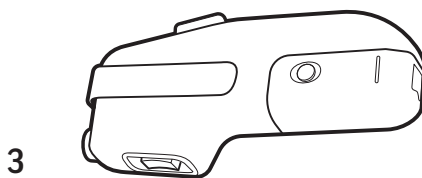
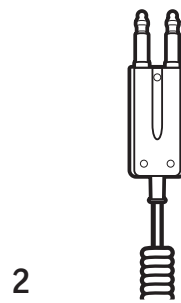
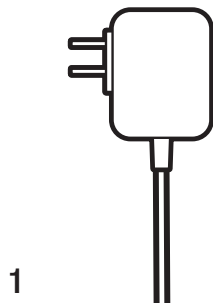

1 AC power adapter: 217111-01

2 Console Interface cable: 217102-02

6-wire, modular-to-PJ7 cable assembly

3 Remote

- Single Channel - North America: 218400-01 UPCS (DECT 6.0)
- Single Channel - Countries outside of North America: 218400-02 (DECT)
- Dual Channel - North America: 218400-03 UPCS (DECT 6.0)
- Dual Channel - Countries outside of North America: 218400-04 (DECT)

4 Battery pack: 218401-01

Accessories

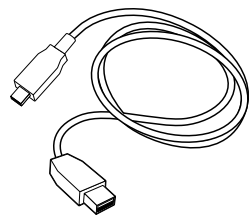

Micro USB cable Connects base to console.

Compatibility of remotes and bases

Use the following table to identify your system's model and determine compatibility based on region and generation. Table includes both CA12CD and CA22CD models.

IMPORTANT Remotes are only compatible with bases of the same generation.

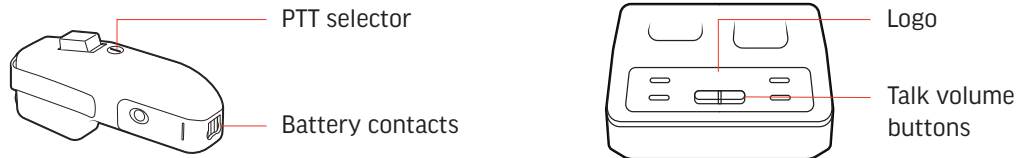

Remote: Color of PTT selector	Remote: Number of contacts on battery pack*	Base: Color of talk volume buttons	Base: Logo	Model & Product generation	Primary region/ DECT Frequency
Black	2	Black	Plantronics	CA12CD, 1st gen	North America (DECT 6.0)
White	2	Black (check label on bottom of base to verify model)	Plantronics	CA12CD/A, 1st gen	Europe (DECT)
Grey	2	Grey	Plantronics	CA12CD-S, 2nd gen	North America (DECT 6.0)
Purple	2	Purple	Plantronics	CA12CD-S/A, 2nd gen	Europe (DECT)
Grey	4	Grey	Poly	CA22CD-SC, 3rd gen CA22CD-DC, 3rd gen	North America (DECT 6.0)
Purple	4	Purple	Poly	CA22CD-SC/A, 3rd gen CA22CD-DC/A, 3rd gen	Europe (DECT)

NOTE * Battery packs with 2 contacts are only compatible with CA12CD models. Battery packs with 4 contacts are only compatible with CA22CD models.

Connect your system

Using the diagrams below, choose the appropriate connection for your system.

IMPORTANT Only 1 connection can be active and plugged into the base at a time. If you choose to switch connection type, unplug and re-insert the power cable to establish a new connection.

Analog

Connect your system with the console interface cable.

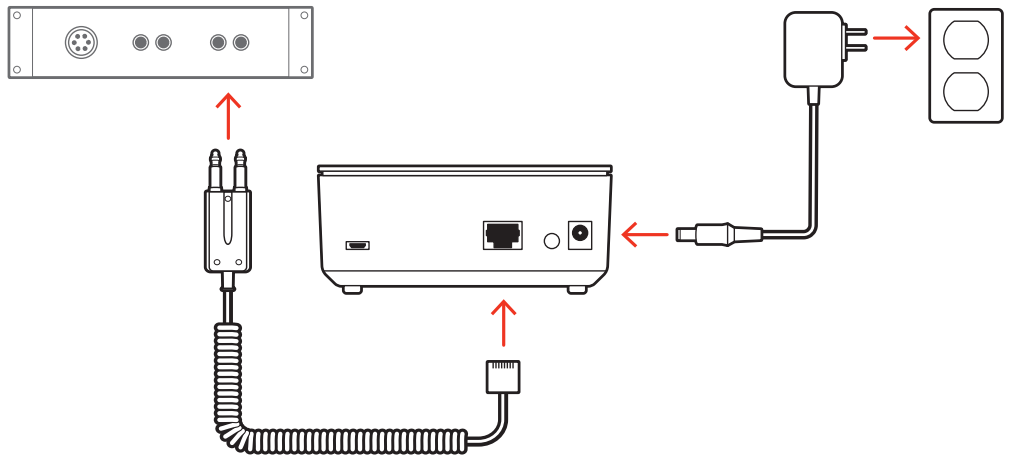

NOTE Base configuration settings

Talk output	Talk  Setting (on bottom of base)
Dynamic	1
Electret	2, 3
Carbon	4 (default; correct in most cases)

USB (USB variant only)

Connect your system with the USB cable.

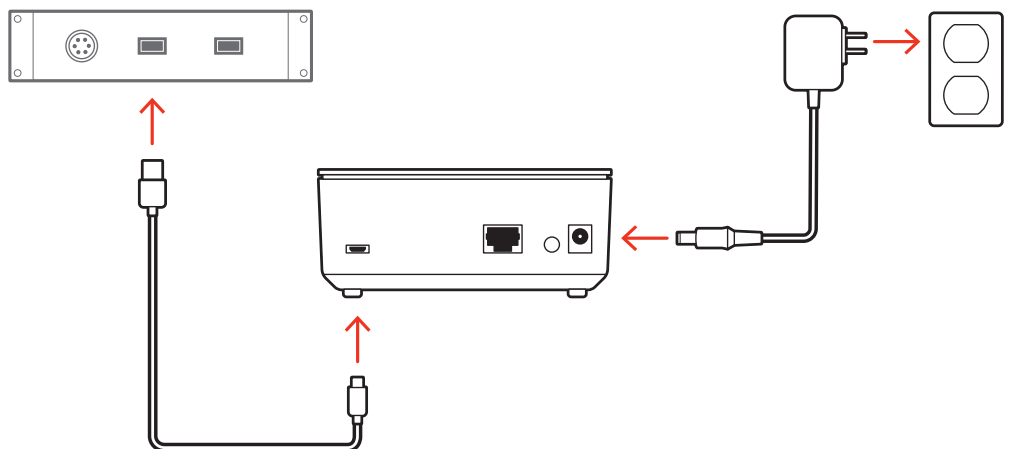

Remote Install battery and connect to headset.

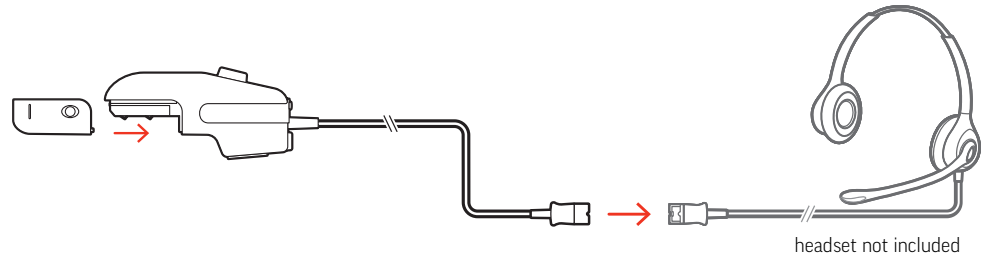

NOTE *Single Channel QD shown. Connection may vary but function is the same.*

Adjust the volume controls

Volume configuration differs by connection.

USB connection

Adjust Listen volume

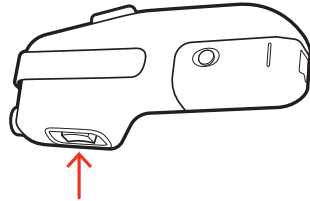

Toggle Rocker switch on remote to fine-tune your listen volume.





IMPORTANT Base volume controls are not configurable or operable for USB connection. Configure additional volume settings with your software interface.

Analog connection

Default volume settings

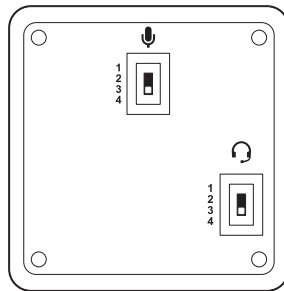
Position 4 is the default setting for Talk  and Listen  switches on bottom of base and correct for most applications.



IMPORTANT Talk  switch position corresponds to your console's microphone input for (1) dynamic-, (2 & 3) electret-, or (4) carbon-mic applications.

If necessary, adjust the talk and listen volume as described below.

Adjust Talk volume

- 1 Adjust the Talk  switch until your caller hears you clearly.
- 2 If fine-tune adjustment is necessary, press the Talk volume + or - buttons on top of base.

Adjust Listen volume

- 1 Toggle Rocker switch on remote to fine-tune your listen volume.

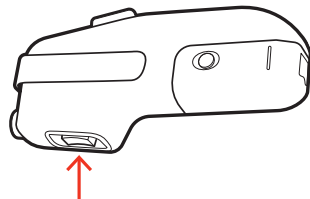

- 2 If larger level adjustments are necessary, adjust the Listen  switch until you hear the caller clearly.

Prevent echoes

Excessively high audio levels can result in distortion and echo. Adjust your equipment's volume controls as described below.

- Turn off or completely decrease your equipment's sidetone control (if available).
- If necessary, set the console receiver and microphone volumes to mid-range.

Subscribe

The remote and base are subscribed (connected) to each other when shipped from the factory. However, if you need to re-subscribe your system or have replaced your base or remote, you can subscribe them as follows:

- 1 Your first step differs when subscribing a new remote versus a new base. Choose A or B:
 - A If subscribing a new remote, turn off the original remote's Audio Link LED and remove its battery.
 - B If subscribing to a new base, turn off the remote's Audio Link LED and do not remove the battery.

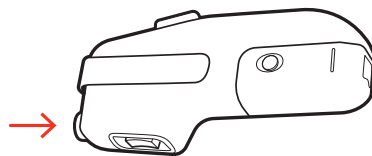

- 2 Press and hold the Subscription button on the back of the base. The base Power LED flashes green.

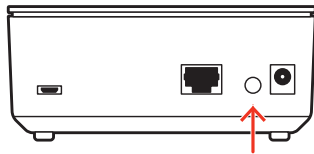

- 3 Hold the remote's Rocker switch in either the up or down position for 3 seconds, then release. The remote's Audio Link LED turns solid green.

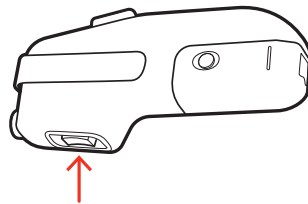

- 4 Subscription is successful when the base Power LED turns solid green and the remote's Audio Link LED turns off. If the Audio Link LED remains off, press it to bring up an audio link.

Charge

Charge your remote

For first use, charge the remote and spare battery for a minimum of 1 hour. Place the remote and spare battery in the base.

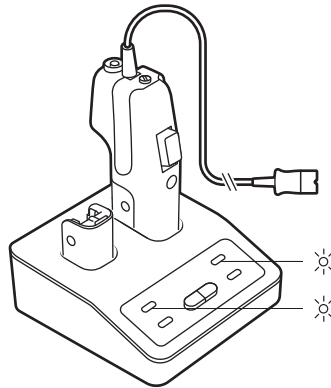

The base charge LEDs flash orange when charging and turn solid green when fully charged. Allow 4 hours for full charge.

Manage batteries

Swap batteries regularly

A fully-charged battery powers your remote for up to 10 hours, however, we recommend swapping batteries approximately every 4 hours.

IMPORTANT *Swapping batteries every 4 hours maximizes the battery life and ensures communications are not interrupted by low batteries.*

Charge remote and spare battery when not in use

Place the remote and spare battery in their charging wells between battery swaps or when not in use.

Low battery warning

Recharge your battery if you hear a single beep every 10 seconds.

Remove battery for storage

Remove battery from remote when storing to prevent the battery from depleting.

Replace batteries

Monitor the performance of your batteries for gradually decreasing talk times and replace as needed.

NOTE *Rechargeable batteries of all types gradually age and lose their ability to give and receive charge. Replace your rechargeable batteries after 3 years or 300 charge cycles, whichever comes first.*

CAUTION *Touching the battery-charging contacts or placing objects other than the batteries and remote in the charging wells may adversely affect the operation of the device.*

System basics

Power remote

Power your remote with a charged battery pack.

- 1 Slide battery pack onto the remote and snap into place without force.

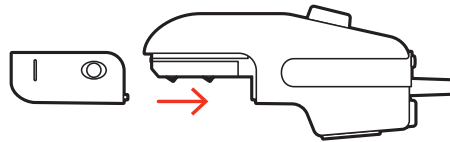

- 2 Remote's Audio Link LED flashes when ready for use.

Key up radio

Press the Push-to-Talk (PTT) button on the remote to key up your radio. The Talk LED on the base turns green.

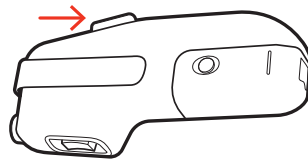

Locking operation

- 1 Align the selector vertically to the remote's center-line.
- 2 Depress the PTT button and slide it down toward the selector until the button locks into place in the ON position.

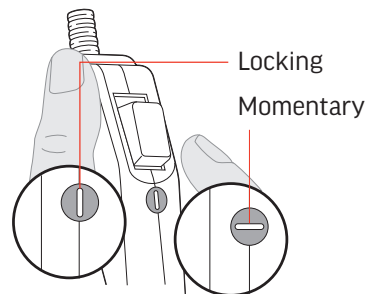

Momentary operation

Turn the selector horizontally from the locking position. The PTT button will default to the OFF position when released.

Adjust headset
microphone volume
(softphone)

Place a test softphone call and adjust softphone volume and PC sound volume accordingly.

Stay within range of your
base

A triple beep warns you if your remote is out of range and has lost its audio link with the base.

Troubleshooting

I hear a triple beep.	Your remote has lost its audio link with the base. Usually, this is due to being too far away from the base. (Note: A triple beep while using the Talk or Listen fine adjust controls indicates that the level is at its nominal setting.)
I hear a single beep every 10 seconds.	Your battery is low and should be changed or charged.
Charge LED is flashing 6 times per second.	There could be an object such as a coin or a paperclip in the charging well.
The base volume controls don't work.	The base is operating in a USB-connected configuration. Base volume controls are not configurable or operable for USB connection. Use the remote's Rocker switch to fine adjust listen volume and your software interface for other volume settings.
Charged batteries are not lasting as long as expected.	Your batteries may need to be replaced. Rechargeable batteries of all types gradually age and lose their ability to give and receive charge.
The base Power LED does not flash green when performing step 2 of the subscription process.	Your base may have an active link with your previous remote. Ensure the previous remote's Audio Link LED is off and its battery is removed.

Support

NEED MORE HELP?

poly.com/support

Plantronics, Inc.

345 Encinal Street
Santa Cruz, CA 95060
United States

Plantronics B.V.

Scorpius 171
2132 LR Hoofddorp
Netherlands

© 2021 Plantronics, Inc. All rights reserved. Poly, the propeller design, and the Poly logo are trademarks of Plantronics, Inc. All other trademarks are the property of their respective owners. Manufactured by Plantronics, Inc.

Model ID: CA22CD-SC has a CA22CD base, (may be followed by /A) and a CA22CDSY remote (may be followed by /A). CA22CD-DC has a CA22CD base, (may be followed by /A) and a CA22CDDY remote (may be followed by /A).

219783-06 06.21